



14500 Coy Drive, Grass Lake, Michigan 49240
734-475-2200 E-mail: sales@coylab.com
www.coylab.com

Humidity Control Glove Box Instruction Manual

INDEX

	<u>Page #</u>
Warranty	2
Warnings	3
1.0 Introduction	
1.1 Glove Box Components Overview	4
2.0 Glove Box Assembly	7
2.1 Arm Port Plugs	8
2.2 Installation of Tubing to glove box fittings	9
2.3 Automatic Humidity Controller Assembly	9
2.4 Dehumidification Apparatus Assembly	10
2.5 Humidification Apparatus Assembly	12
2.6 Dry Nitrogen Purge System Assembly	15
3.0 Operation of Components	
3.1 Automatic Humidity Controller	17
3.2 Dehumidification System (Desiccant)	18
3.3 Dry Nitrogen Purge System	19
3.4 Humidification System	19
4.0 Care and Cleaning	
4.1 Care & Cleaning Dehumidification System	21
4.2 Care & Cleaning Humidification System	21
4.3 Care & Cleaning of Glove Box	22
4.4 Care of Gloveless Sleeves & Gloves	23

WARRANTY

This product is warranted against defects in material and workmanship during the first 12 months after original date of shipment.

The factory will, at its option, repair or replace defective material within this period at no charge for parts and labor.

All returns or exchanges must first be authorized by COY LABORATORY PRODUCTS, INC.

PHONE: 734-475-2200
FAX: 734-475-1846
E.MAIL: sales@coylab.com

COY LABORATORY PRODUCTS, INC.
14500 COY DRIVE
GRASS LAKE, MI 49240

The responsibility of COY LABORATORY PRODUCTS, INC., is limited to the purchase price of this product, and COY LABORATORY PRODUCTS, INC., will not be responsible for any Consequential damages.

This warranty does not cover damage in shipment or damages as a result of improper use or maintenance of this product. This warranty does not cover damages caused by excessive line transients on the AC supply line.

WARNINGS

1. If the Glove Box is used with any type of gas purge, the pressure regulator must not be set higher than 15 psi. Flow Rates greater than 15 psi may damage the glove box and void the warranty.
2. Never obstruct gas flow in or out of the Pressure Relief Valves.
3. The **Polymer & Aluminum Glove Box** styles are not intended for vacuum or high pressure operation.
4. Running the humidity apparatus dry will damage the pump and void the factory warranty.
5. To improve the life expectancy of each apparatus (humidification/dehumidification) the user should turn off the apparatus not in use at the time with the Automatic Humidity Controller. For example, when dehumidifying the chamber, or when the desired set point is below ambient humidity levels, turn the humidification switch off.
6. Only distilled water should be used with the humidification apparatus to prolong product life.
7. **Never pull a vacuum** on Polymer or Aluminum Glove Box. This could crack/damage the glove box and void the warranty.

1.0 Introduction

This Glove Box is designed for humidity control applications where there is a need to control the humidity either below and/or above ambient conditions. It can be used in either Automatic or Manual Control mode.

The Humidity Controller provides automatic monitoring and control of the relative humidity. It activates the necessary system when the moisture level deviates from the adjustable set point.

The safety relief/bleed valves provide pressure relief with the control system and also function as check valves, ensuring no moisture or contaminants enter the Glove Box in the event of a system failure causing negative pressure.

The Manual Control requires an operator's periodic check with the supplied Hygrometer to be sure the humidity is as desired. Then, turning the appropriate equipment pump switch "ON" or "OFF" will control the desired level.

1.1 Glove Box Components Overview

Standard Equipment Includes:

- | | |
|---------------------------------------|--|
| 1. ¼" Ball Valve | 7. Automatic Humidity Controller |
| 2. Pressure Relief Valve | 8. Dehumidification Apparatus |
| 3. Plug Strip | 9. Added Capacity Dryer
(2 person units only) |
| 4. Diaphragm Top | 10. Humidification Apparatus |
| 5. Gloveless Sleeves & Arm Port Plugs | 11. Circulation Fan |
| 6. Large Side Door | |

¼" NPT Ball Valve

This ball valve located on the upper right side of the glove box (see figure #1 page 7) can be used for purging operations. The ball valve is equipped with a ¼" o.d. Quick Disconnect female and male fittings for Tygon tubing. See section 2.2 (page 9) for installation of tubing and Quick Disconnect Fittings

Never purge the glove box at a higher rate than 15 psi (with ¼" o.d. Tubing). Doing so could over pressurize and damage the glove box.

NOTE: Damage from over pressurizing the glove box will void the warranty.

Pressure Relief Valve

The pressure relief valve relieves the glove box of large internal pressure changes associated with gas purges. The valve is an automatic system that simply allows

gas to escape to the room atmosphere when the glove box internal pressure rises.

The pressure relief valve can handle up to 15 psi of gas flow. Larger flow rates may over pressurize and damage the glove box.

Plug Strip & Feed-Through Adapter

A power supply is sealed into the glove box through the COY Feed-Through Adapter. The plug strip is equipped with a circuit breaker and ON/OFF switch.

The Feed-Through Adapter is a rubber stopper that has been cut apart to accept the cord of the plug strip and resealed with silicone and placed in the plastic feed through, which is then attached to both sides of the glove box by threading the cap nut. Please note when loosening or reattaching the feed through the black rubber O-ring must be placed on the outside of the glove box to ensure an airtight fit.

Diaphragm Top

The diaphragm top is designed to compensate for small volume changes on the interior of the glove box associated with the user entering and exiting the glove box through the gloves.

Manufactured from 20 mil Poly Vinyl Chloride (PVC) the vinyl is durable and long lasting. When the glove box is purged, this top will expand until the pressure relief valve activates and relieves the excess pressure.

***Please note:** on some custom glove box designs the Diaphragm Top is located on the back wall of the glove box or other location. For these designs please make sure the diaphragm has room to expand and that there are no sharp objects that could damage the vinyl.*

Gloveless Sleeves & Arm Port Plugs

Gloveless Sleeves allow for barehanded entry into the glove box with the cuff fitting snugly around the users forearms to ensure an airtight fit.

The Arm Port Plugs seal the glove box atmosphere when not in use. See section 4.4 (page 21) for details on replacing a gloveless sleeve or cuff.

Large Side Door

Access point for large equipment. Latched at three separate points to ensure airtight seal.

Automatic Humidity Controller

Measures and controls the humidity levels inside the glove box by turning on and off the pumps that run the Humidification and Dehumidification Apparatus. All based on the set-point chosen by the user. Controller is placed outside the glove box in a convenient location for the user.

Dehumidification Apparatus

Consist of the Desiccant Cartridges mounted on the rear of the chamber and the pump that circulates air from the glove box through the desiccant and back into the glove box.

Added capacity dryer

Added desiccant capsules to increase time between desiccant regeneration. Standard on all 2 person (5 & 6 ft) glove boxes. Optional on all other glove box sizes.

Humidification Apparatus

Consist of mounted water chamber on the interior of the chamber, water reservoir and water pump located on the exterior of the glove box. This unit adds moisture to the glove box when pump is operational. Excess water is drained back to the reservoir through the large drain tube.

Circulation Fan or Heated circulation fan

Circulates glove box atmosphere ensuring proper humidity mix throughout the glove box. This unit should always be plugged in and working.

Dry Gas Purge System

An alternative means to drying the glove box by using any inert dry gas to lower humidity levels. This automatic system has adjustable flow meters to control drying times. The Electronic solenoid is triggered by the Automatic Controller to allowing gas to flow into the glove box. The Automatic Pressure Relief valves vent excess pressure. System can be used on tandem with Dehumidification System.

Figure # 1 Glove Box Configuration

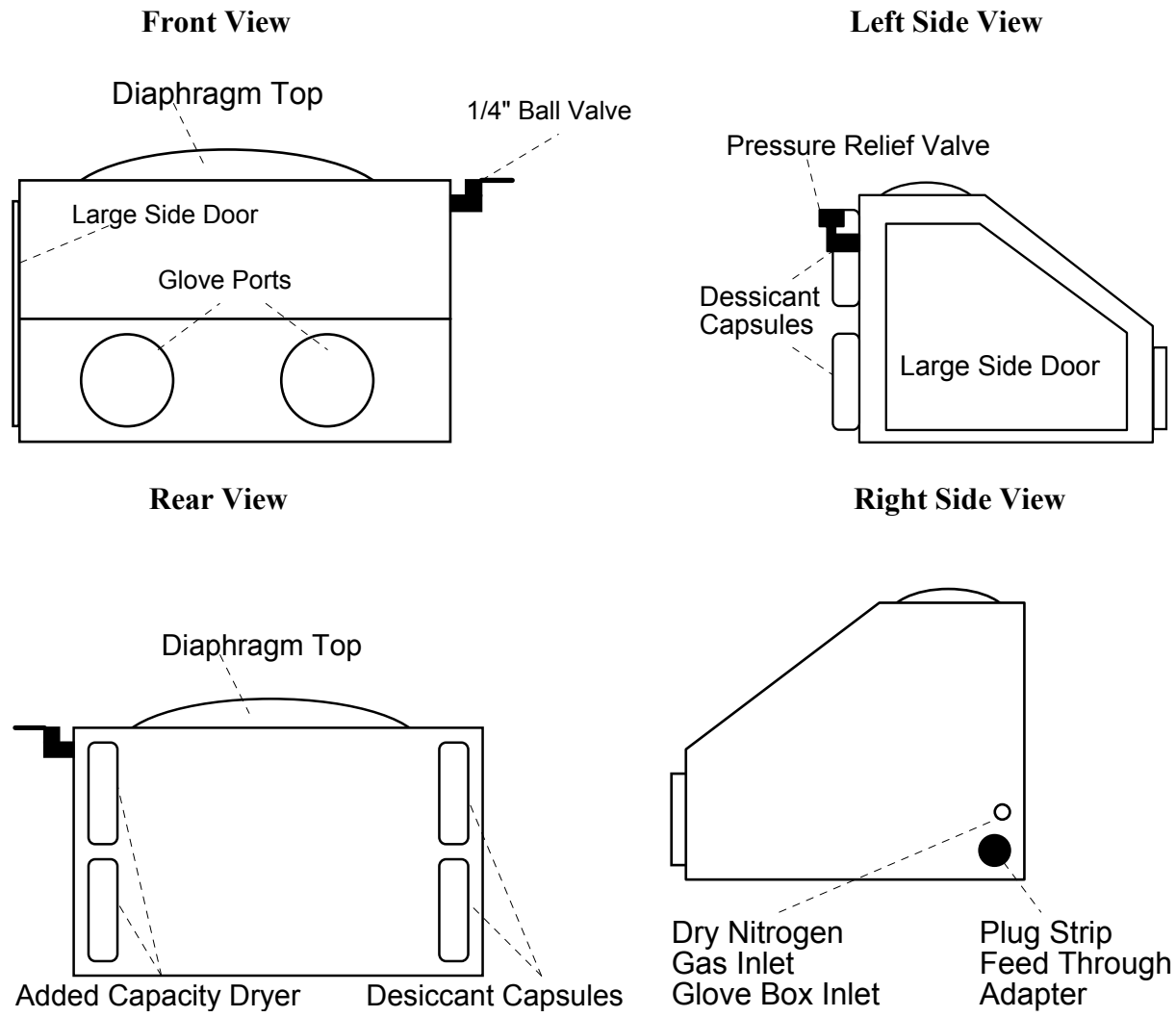

2.0 Glove Box Assembly

Most of the Glove Box has been pre-assembled at the factory with all accessory parts, Pressure Relief Valve, 1/4" Ball Valve, Large Side Door, Gloveless Sleeves, and Plug Strip installed. Below are the basic instructions for assembling the rest of the Glove Box.

Remove all packing and shipping boxes from the interior of the glove box.

2.1 Arm Port Plugs Assembly

Install Arm Ports as illustrated by figure #2. To allow easy access in and out of the glove box, position the arm ports on the Arm Port Holder inside.

HINT: For easy operation of the arm port plugs, when placed in the Arm Ports to seal the atmosphere, tilt the bottom portion of the Arm Port Plug in first and then tilt the top portion in to seal the atmosphere.

NOTE: For units installed with Iris Ports the Arm Port Plugs are designed to seal from the outside and are not kept inside the glove box.

Figure # 2 Arm Port Plug Operation

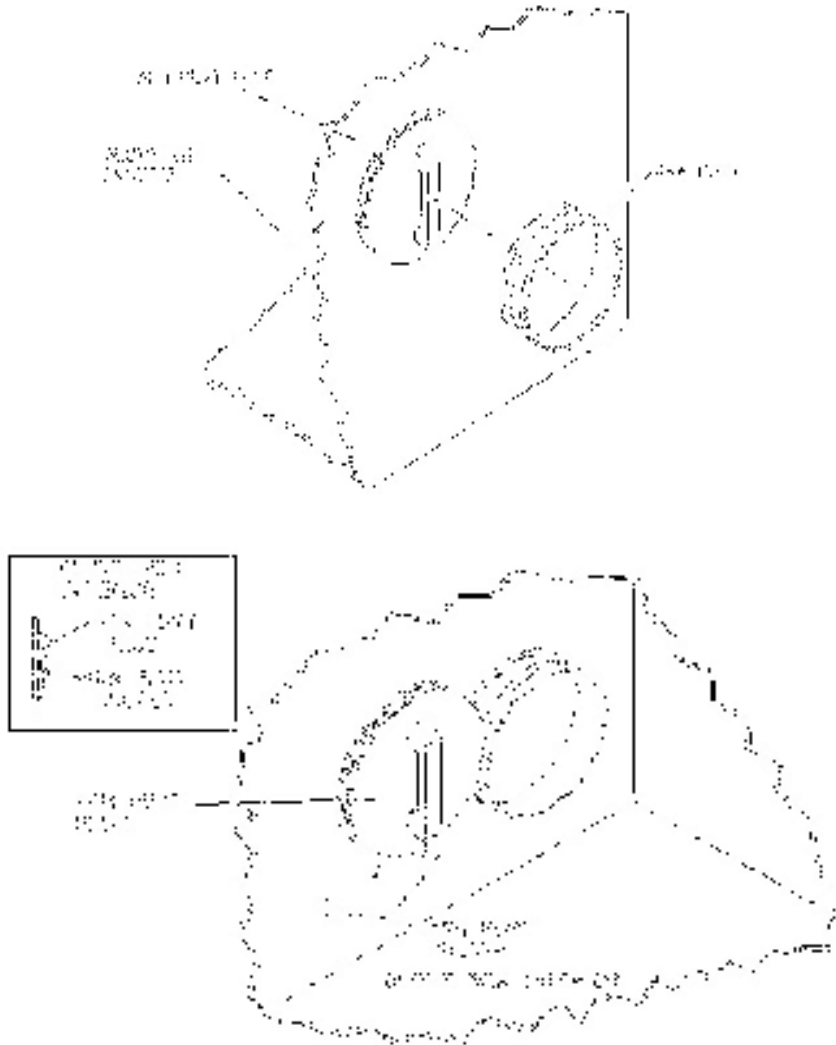

2.2 Installation of Tubing to Quick Disconnect Fittings

To install Tygon tubing to the fittings, follow the instructions listed below and figure #3 (below) as a reference.

1. Place a female fitting on each end of tubing.
2. Place 2 ty-wraps around the hose barb on the female fittings and pull them as tight as possible.
3. Cut off excise ty-wrap.
4. Insert Female fitting connected to the tubing to the Male fitting on the Glove Box Ball Valve. When fitting is seated correctly, you will hear a “click”.
5. To disconnect the tubing, depress the silver tab on the male fitting and separate.

When disconnected, the fittings on the glove box automatically seal the glove box atmosphere.

NOTE: Never purge the glove box at a higher rate than 15 psi. (with 1/4" o.d. Tubing) Doing so could over pressurize and damage the glove box. Damage from over pressurizing the glove box will void the warranty.

Figure # 3 Tubing connection to Quick Disconnect Fitting

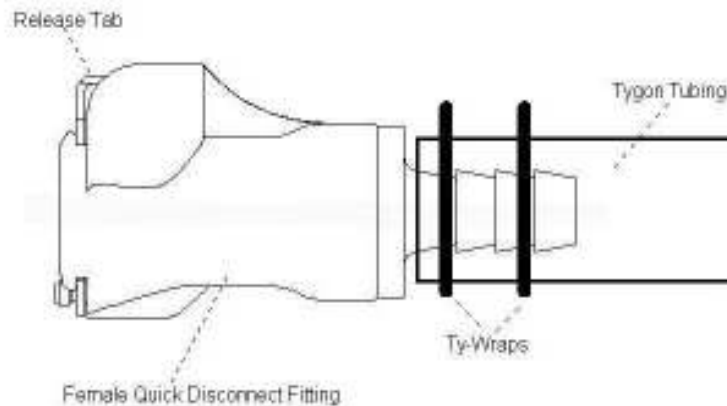

2.3 Automatic Humidity Controller Assembly

Unpack the humidity controller and position it so that it is easily accessible to the user (nearby shelf or space on the bench top). Do not place on top of the glove box during operation as the Diaphragm Top needs to be able to expand without interference. Keep in mind that the controller is limited by the length of the sensor cable and the cords for the humidification and dehumidification pumps.

Once the Controller is situated to your satisfaction, install the sensor into the rear wall of the glove box following figure #4 and the instructions listed below.

Figure # 4 Sensor Connection

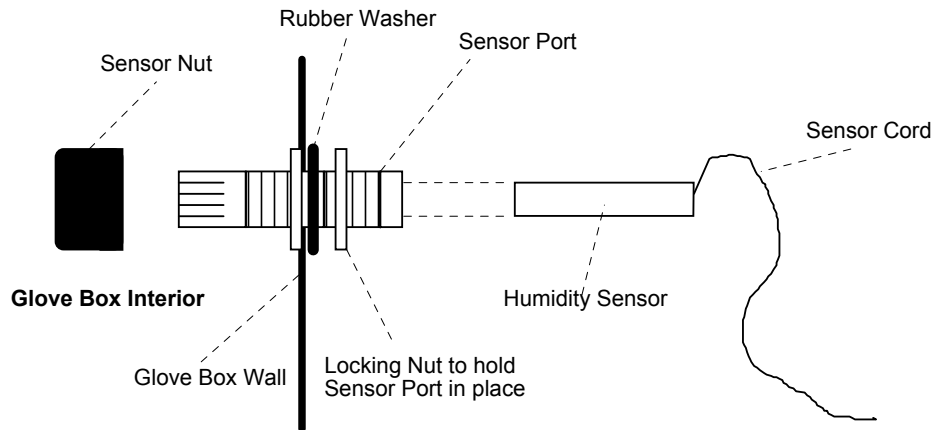

1. Make sure the Locking Nut is tight to the back of the glove box. This is done at the factory but may have come loose in the shipping and unpacking process.
2. Remove Sensor Nut and insert Humidity Sensor through the port. Once in place, tighten the Sensor Nut over the port and Sensor. This seals the Glove Box Atmosphere.

Finally plug the sensor into the back of the Humidity Controller. See Figure # 11 on page 16 for details. Make sure the humidity controller is unplugged and turned off until all other systems are connected.

2.4 Dehumidification Apparatus Assembly

The Dehumidification Apparatus (desiccant capsules) are installed at the factory, and connected to the glove box with the tubing. It is at this point you should now connect the vacuum pump to the desiccant and glove box with the provided Tygon tubing. Connections should be made using figure #5 as a guide or figure # 6 (page 11) if the Added-Capacity Dryer has been purchased.

Figure # 5 Dehumidification Connections

Rear View of Glove Box

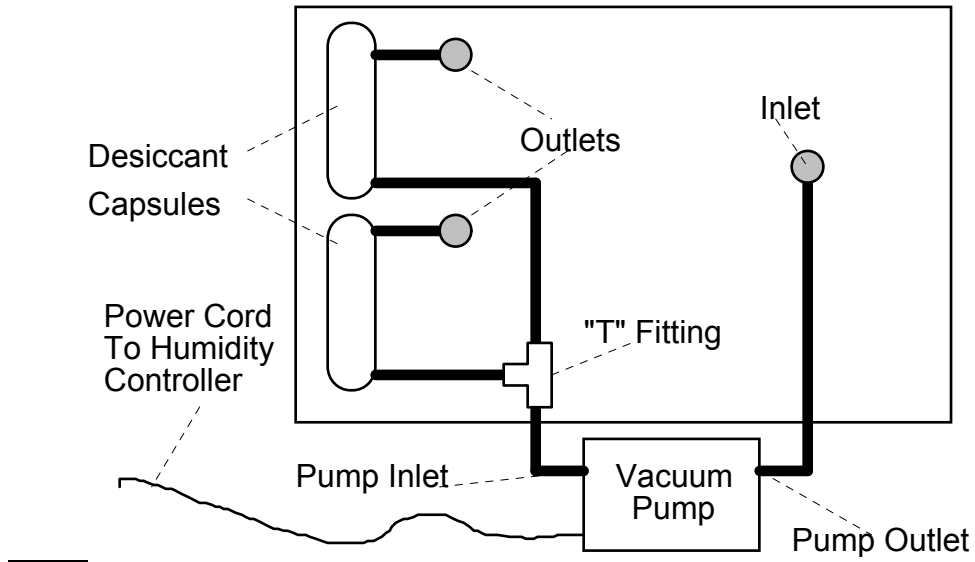
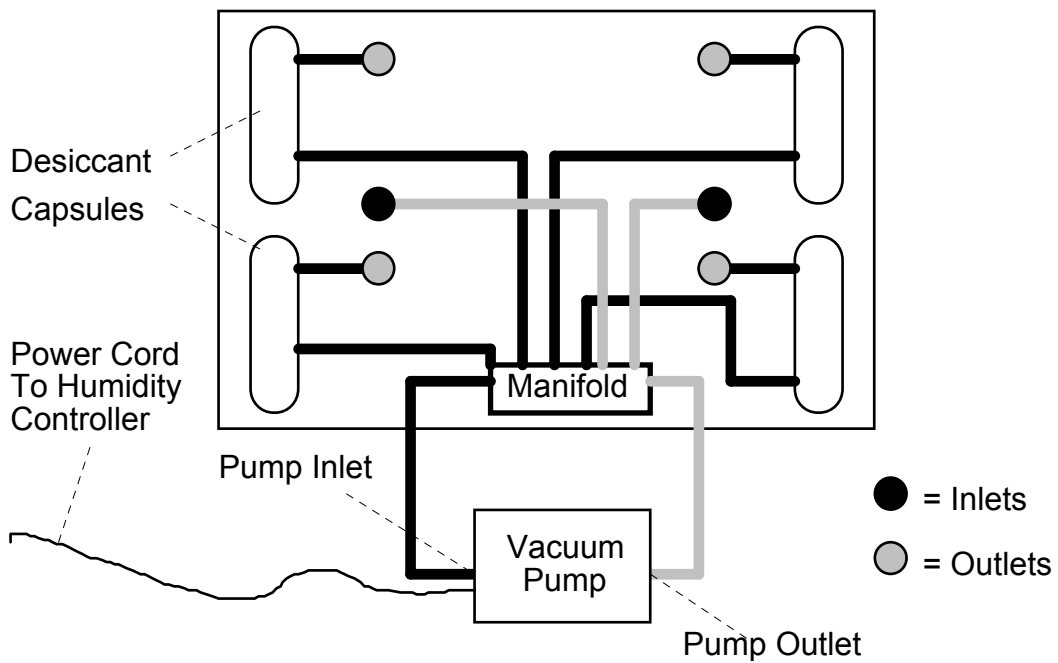

Figure # 6 Dehumidification Connections for Added-Capacity Dryer

Rear View of Glove Box



The final step in setting up the dehumidification part of the system is to plug the Vacuum Pump into the back of the Automatic Humidity Controller labeled “DECR” (See figure # 12 on page 18 for more details).

NOTE: The direction of the air traveling through the system should be as follows:

Glove Box → Desiccant → Pump → Glove Box

This ensures the majority of the air is dried prior to entry into the pump. Moist air will corrode the pump and shorten its lifespan.

Manual Control Connection: Connection is exactly the same as mentioned above except the unit is equipped with a digital hygrometer that should be placed inside the glove box for measuring humidity levels. The Pump power cord is equipped with an ON/OFF switch which should be placed in a position that is easy to reach for the user. The power cord is plugged into a nearby power outlet.

2.5 Humidification Apparatus Assembly

The Humidification Apparatus consist of the Sonicator, Water Reservoir, Pump Housing and Connection Tubing.

Place the Sonicator into the Glove Box Reservoir. The Cord has been sealed into the rubber stopper at the factory. This rubber stopper is placed in the pre-drilled hole on top of the water reservoir. Leave the stopper out until after you’ve added water to the system.

Now Place the Pump Housing in a convenient location near the glove box. This unit can be above or below the glove box. NOTE: In a manual system you will want the ON/OFF switch in an easily accessible location.

Plug in the Ultra Sonic Humidifier to the Pump Housing and connect the tubing as displayed in Figure #7 (make sure the Pump Housing power switch is in the OFF position).

Now add water through the rubber stopper opening. Fill the reservoir up to the etched line marked on the container, this will be about 3” (7.6 cm) above the Sonicator. Filling the reservoir beyond this mark will severely hamper the humidifiers performance.

Plug the rubber stopper into the hole sealing the system and the glove box.

Finally Plug the pump housing power cord into the “INCR” outlet on the rear of the Humidity Controller (see figure #13 page #19).

Refilling the Water Reservoir in a Sealed Atmosphere

Some units will be used where the user does not want to compromise the glove box atmosphere (clean or N₂ environments for example). For these applications a Refill Reservoir has been provided with tubing and a quick disconnect fitting.

To operate place the Refill Reservoir above the Water Reservoir, and fill with water. Disconnect the tubing from the Pump Hosing Outlet and connect to the tubing from the Refill Reservoir. Once connected the water will begin to flow into the Water Reservoir. To stop the flow simply disconnect the tubing. Running the unit with water levels less than ½" (1.27 cm) may damage the unit.

Glove box atmosphere is maintained as the quick disconnect tubing is self sealing when disconnected.

NOTE: Distilled water will prolong equipment life but is not necessary for the operation of the system.

Figure # 7 Humidification Tubing Connections

Rear View of the Glove Box

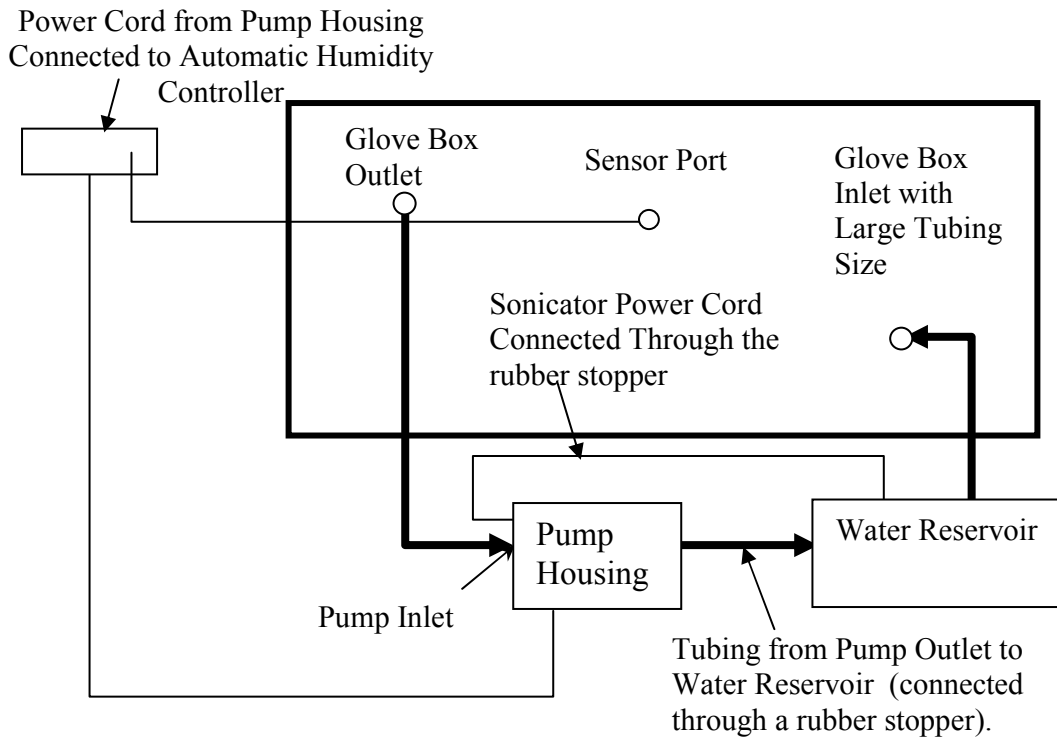

2.51 Humidification Apparatus Assembly for Heated Units ONLY.

Note: If you have purchased a glove box with heating options the placement of the Water Reservoir is located inside the glove box for optimal efficiency at elevated temperatures. Use the following instructions for set-up, operating instructions remain the same.

The Humidification Apparatus has had the Glove Box Water Reservoir installed from the factory on the interior. All other items have to be installed and connected by the user.

Start by placing the Ultra Sonic Humidifier into the Glove Box Water Reservoir. The cord has already been sealed in the rubber stopper which is placed in the pre-drilled hole on the back of the glove box. Place the Sonic Humidifier in a corner of the water reservoir, failure to do so could result in water splashing through the humidifier glove box opening.

Next place the Pump Housing in a convenient location near the glove box. This unit can be above or below the glove box. Plug the Ultra Sonic Humidifier to the Pump Housing, and connect the tubing as displayed in Figure #8 and 9 (make sure the Pump Housing power switch is in the OFF position. It is important to connect the inlet and outlet tubing properly. The pump outlet has to connect to the Glove Box Water Reservoir.

Now the system is ready to have water added to it. For this operation place the Water Refill Reservoir (clear box with quick disconnect fitting) above the Glove Box Reservoir. Fill the Refill Reservoir with water then connect the tubing to the Glove Box Reservoir. Once the quick disconnect fitting is connected the water will flow into the Glove Box Reservoir. Fill the Glove Box Reservoir up to the bottom of the rubber stopper. To stop the flow of water simply disconnect the tubing. A latch has been provided on the reservoir to secure tubing when not in use.

NOTE: Distilled water will prolong equipment life but is not necessary for operation of the system.

Figure # 8 Humidification Tubing Connections for Heated Systems

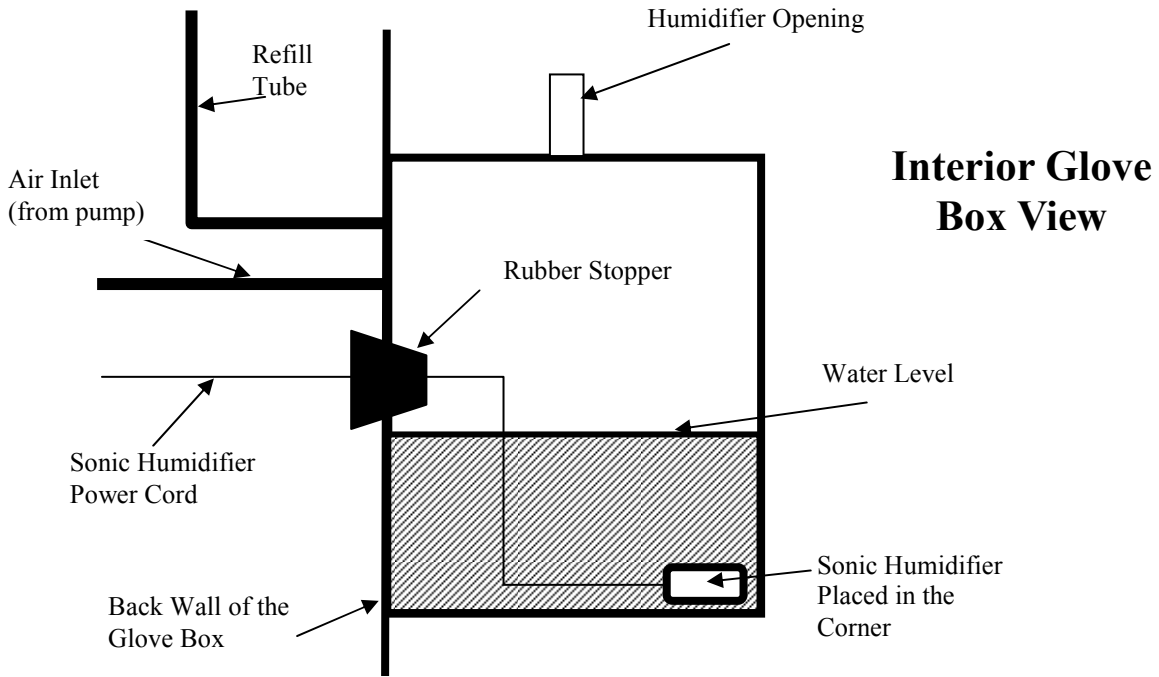
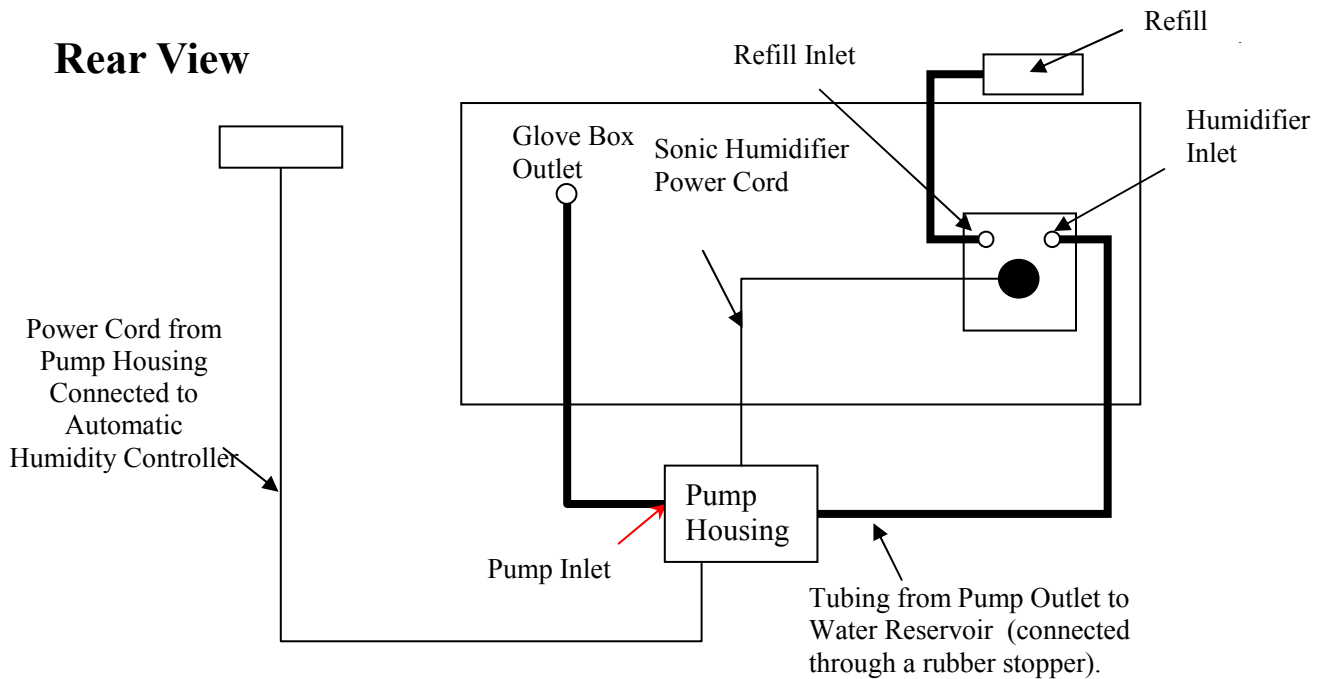

Figure # 9 Humidification Tubing Connections for Heated Systems



Manual Humidification Set Up: Exactly as stated above except unit includes Digital Hygrometer to monitor humidity levels (% Rh). This should be placed inside so that it can easily be monitored. The plug strip's ON/OFF switch turns the humidification system "ON" and "OFF" therefore this plug strip should be located within easy access for the user.

2.6 Dry Nitrogen Purge System (additional option or substituted for Desiccant System)

If the Dry Nitrogen Purge System has been purchased with the unit, connect the gas lines from the tank to the Purge Unit and Glove Box as shown in Figure's # 10 & 11 (below and on page 15). The Purge Unit should be plugged into the back of the Humidity Controller in the outlet labeled "DECR" for operation (see figure # 13 on page 19).

If the unit is an addition to the desiccant system for drying, then both the dehumidification pump and Dry Nitrogen Purge System will be plugged into a supplied plug strip and the plug strip will be plugged into the "DECR" receptacle on the Humidity Controller (see figure # 13 on page 19).

Figure # 10 Dry Nitrogen Purge Connections

Right Side View

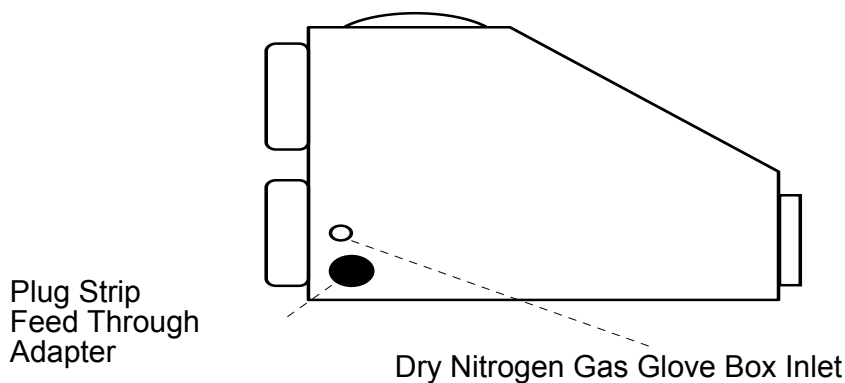
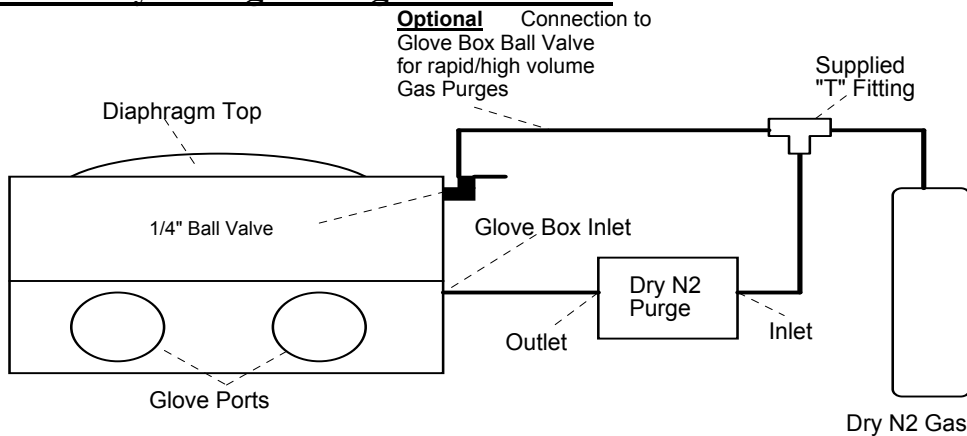

Figure # 11 Dry Nitrogen Purge Connections



PID Heated Fan

Set point

To adjust temperature press release the up and down arrow keys in the direction you desire. The temperature will increase or decrease by 0.1 C. Hold the arrow key and the temperature will change at a faster rate. Release the button when you reached the proper set point.

Calibration

Press and release the advance key until you come to CAL use the up or down keys to calibrate.

Increasing this number will increase your process value.

** Warning

Do not change any other setting in the menu setting. Doing so could cause the controller to malfunction.

Figure #12 Heated Fan Controller

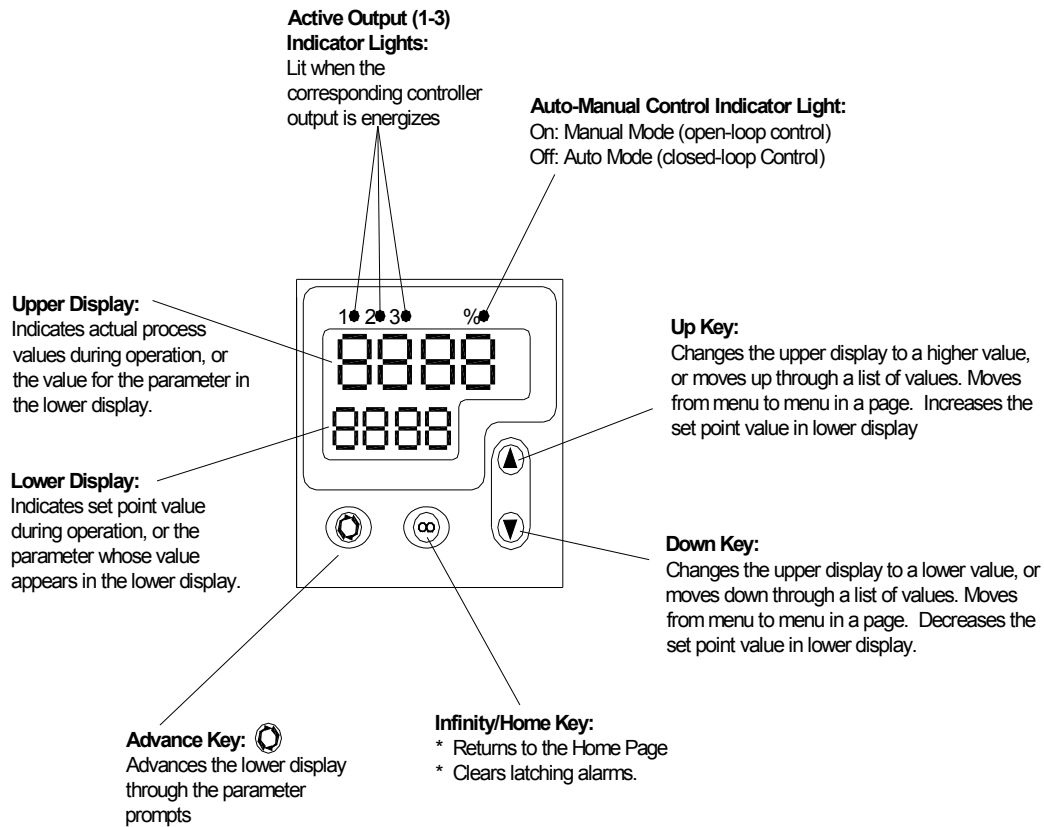

Operation of Components

3.1 Automatic Humidity Controller

Use Figures #13 & 14 as a reference

- 1.) With the appropriate systems plugged into the back panel of the Controller, plug the controller into an appropriate power supply outlet and turn the controller “ON”.
- 2.) Adjust the set point by pressing and holding the “*” Button. The letters designating percent relative humidity will appear (rh) followed by the current set point value.
- 3.) To adjust the set point higher, press the “▲” button. To adjust the set point lower, press the “▼” button.
- 4.) Turn the appropriate INCR (increase % Rh) DECR (decrease % Rh) as needed
- 5.) The Microprocessor will determine the amount of output from the operating system needed to maintain the desired set-point. If less than the full output capacity of the operating system is required, the controller will provide pulses of power to the unit to limit the output. The outlet (and operating system) will be turned ON/OFF cyclically to obtain an average appropriate to maintain the desired set-point.

Figure # 13 Connections on Rear of Humidity Controller

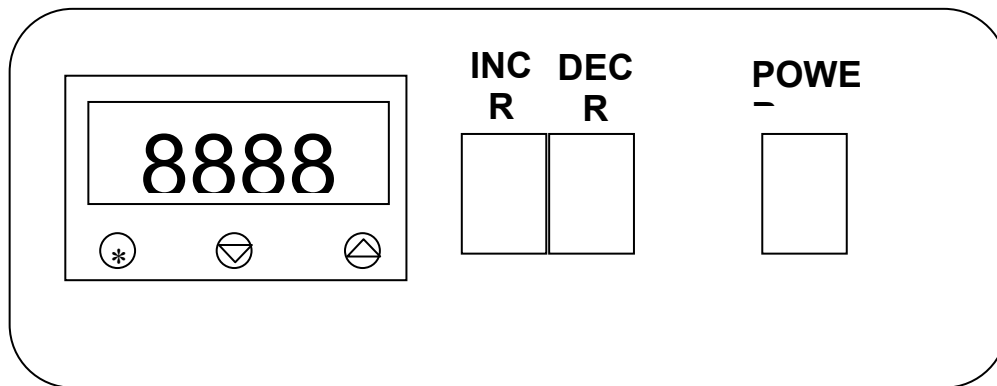
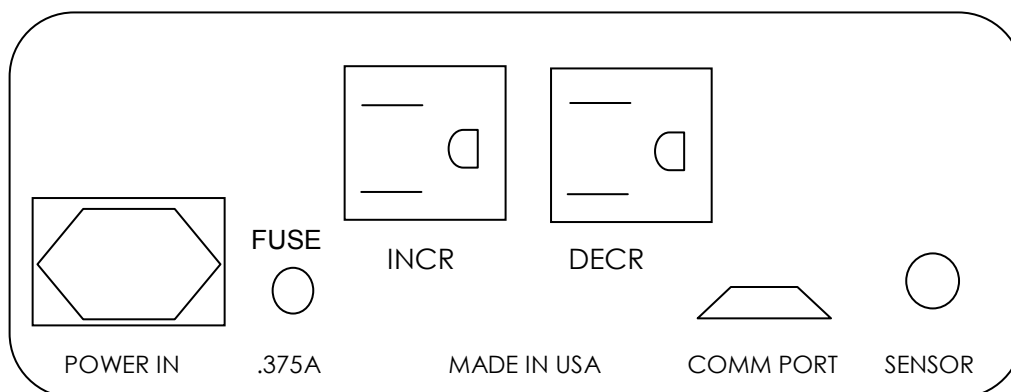

Figure # 14 Front Panel of Humidity Controller



3.2 Dehumidification System (desiccant)

When in operation the dehumidification System draws glove box atmosphere through the desiccant capsules, drying the “wet air”, then through the vacuum pump and back into the glove box.

Automatic Mode

Turn on the automatic controller, turn on the DECR switch, and choose the desired set point below ambient humidity levels.

*SETTING HUMIDITY LEVELS: press and hold the * and down or up arrow buttons on the front of the humidity controller to adjust levels. Release when desired set point is reached.*

The controller will activate the dehumidification pump whenever the sensor detects a reading above the chosen set point.

NOTE: a Red Light on the digital readout will appear when the dehumidification system is operation.

Manual Operation

Turn the switch to the vacuum pump on and monitor the Humidity readings on the digital Hygrometer provided. Turn the pump ON/OFF based on your desired set-point and the readings. If a continually dry atmosphere is required it is okay to leave the pump on for extended periods of time.

Performance

Attainment of the desired humidity will vary according to the desired level, the ambient or room humidity level, the glove box size, air flow rate and glove box contents.

Frequency of door activity and room humidity levels will thereafter determine the systems ability to maintain the desired level.

By way of reference, tests at the factory indicate the humidity level in a 3 ft. wide (10 cu. ft.) Polymer Glove Box will drop from 70% Rh to <5% in approximately 1.5 hours. The test glove box had 2 desiccant capsules and the pump was at its maximum flow rate of 1.25 cubic feet per hour (CFH).

HINT: To achieve optimum performance at low levels you may need to place a cuff length glove on the gloveless sleeves.

Regeneration of Desiccant

Indicating Desiccant displays the moisture saturation level by a color change (blue to pink). To rejuvenate the desiccant, spread in thin layers on a pan or cookie sheet in an oven and bake for 1-2 hours at 200° C. Allow desiccant to cool, and then return to acrylic capsule.

3.3 Dehumidification System (dry N2 purge)

When in operation, the Dry Nitrogen Purge System pumps in the desired gas through the installed distribution tube. The dry air pushes out moist air in the glove box through the pressure relief valve.

*SETTING HUMIDITY LEVELS: press and hold the * and down or up arrow buttons on the front of the humidity controller to adjust levels. Release when desired set point is reached.*

To operate, turn “ON” the Dry Gas Purge unit, turn “ON” the DECR switch and then choose a desired set point. The controller will purge gas in automatically based on the chosen set point and the measured humidity readings.

The controller will activate the Dry Gas Purge whenever the sensor detects a reading above the chosen set point.

NOTE: a Red Light on the digital readout will appear when the dehumidification system is operation.

Performance

Attainment of the desired humidity will vary according to the desired level, moisture content of gas being purged into the glove box, the ambient or room humidity level, the glove box size, air flow rate and glove box contents. Frequency of door activity and room humidity levels will thereafter determine the systems ability to maintain the desired level.

Test Data: 5 ft. Glove Box (25 cubic ft.) was used for the test at the factory with the nitrogen gas regulator set at 15 psi and the Dry N2 Purge System set at 100 scfh. From 71% Rh to 12% Rh took 54 minutes, and used 1025 psi of gas.

3.4 Humidification System

If you have the Manual Control Version, plug the Pump Housing into an appropriate power outlet. Use the Pump Housing Switch to manually control the operation of the Pump and Sonic Humidifier. If you have the automatic system, plug the Pump Housing into the rear of the Controller. In both cases the inline Pump switch must be “ON”.

Automatic Mode: Turn on the automatic controller, turn on the INCR switch, and choose the desired set point above ambient humidity levels.

*SETTING HUMIDITY LEVELS: press and hold the * and down or up arrow buttons on the front of the humidity controller to adjust levels. Release when desired set point is reached.*

The controller will activate the humidification pump whenever the sensor detects a reading below the chosen set point.

NOTE: a Green Light on the digital readout will appear when the dehumidification system is operation..

Manual Mode: Exactly as above except monitoring is done with the digital Hygrometer and Pump Housing is plugged into a suitable power supply.

Sonic Humidifier Care & Warnings:

- ✓ Be careful of the water level sensor switch, do not grab/hold this to lift the unit up or scratch/drop it, doing so can damage the sensor
- ✓ Do not move the unit or handle the cable when in operation. Do not place your finger on the ceramic disc while in operation as the vibration will hurt but is not an electric shock.
- ✓ Do not operate the humidifier when there is not enough water in the reservoir or dry. This will cause the sonicator to not function correctly and will shorten it's life. For proper operating never let the water levels drop below 1/2 “ above the sonicator

Sonic Humidifier Maintenance & Service:

- ✓ Clean the ceramic disc and the surface of the mister with a soft cloth in clean water.

Do not use abrasive cleaners to clean any part of the Sonic Humidifier.

- ✓ If the unit can not generate mist after running for a long time, check water levels in the Water Reservoir. If the LED lamp is also off, check the power connection.
- ✓ If the unit can not generate mist, but only water spray then the Sonic Humidifier is good but the water is dirty and needs to be replaced. To do this remove the rubber stopper on the Reservoir and tilt the glove box back until the old water drains out of the opening. Replace the Sonic Humidifier and refill with fresh water.
- ✓ After running for approximately 3000 hours the mist generated will be noticeably reduced, this is an indication that a new ceramic disc is needed. Please contact COY Labs for part number and current pricing.

4.0 Care and Cleaning

4.1 Care and Cleaning (Dehumidification System)

Periodically the Desiccant will need to be rejuvenated. This can be done by pouring the desiccant out of the capsule and placing it in an oven to dry. The drying time is 1-2 hours at 200° C. Allow the desiccant to cool completely prior to returning it to the acrylic capsules. Desiccant should be replaced once a year based on average use.

4.2 Care and Cleaning (Humidifier)

The Humidifier must be cleaned regularly to maintain peak performance. Ordinary tap water contains many minerals and chemical which can leave deposits and affect the absorbency of the wick. COY recommends using only distilled water because of this.

When cleaning is necessary, unplug the electrical cord and carefully remove the Fan Assembly from the black rubber Feed Thru adaptor. With a soft cloth and vinegar, wipe the whole assembly to remove any dirt and mineral deposits. Thoroughly rinse with clean water and allow drying before reconnecting electrical power.

Do not clean any part of the system with solvents or with water hotter than 100° C. If you do not intend to use the system for an extended time, empty all water from the system and clean with vinegar. This will help prevent a buildup of mineral deposits and bacterial growth.

4.3 Care and Cleaning of the Glove Box

Care of Polycarbonate material

There are several precautions you can take to prolong the life of your glove box.

Precautions you should carefully follow are:

1. Do not use abrasive cleaners at any time on the Polycarbonate portions of the glove box
2. Do not use any solvent like liquids to clean the plastic. Isopropyl alcohol is acceptable as well as a mild bleach solution (5-10%).
3. Keep equipment and shelving units within easy reach so you do not stretch the chamber sleeves.
4. Rings and jewelry should be removed prior to using the glove box so as the polycarbonate is not scratched or the sleeves and gloves are not torn. Finger nails should also be clipped short.
5. Protect the glove box from organic solvent fumes and nearby painting and plastering. If splashed, wipe immediately while wet with a soft cloth.

Cleaning the Polycarbonate

Dust and clean with a soft cloth or chamois having first sprayed on a plastic cleaner. (COY part no. 1600-480) The use of a mild soap or detergent and plenty of water is good. Dry with a soft cloth or chamois.

Minor scratches can be removed by hand polishing. Polishes are best applied with a soft cloth dampened with water first. Several applications may be necessary, but most minor scratches can be reduced and the clarity improved in a short time.

4.4 Care of Sleeves and Gloves

The arm length gloves are made of neoprene rubber and are susceptible to punctures and tears. Wear cotton gloves when working with sharp objects. Remove jewelry. If a hole is punctured in the glove, it must be replaced. Do not use the glove box until the damaged gloves have been replaced.

Gloveless Sleeves are standard with the Humidity Control Glove Box but Sleeve Length Gloves may be substituted for these.

The arm length gloves and gloveless sleeves are made of neoprene rubber and are susceptible to punctures and tears. Wear cotton gloves when working with sharp objects.

Remove jewelry. If a hole is punctured in the glove/sleeve, it must be replaced. Do not use the glove box until the damaged gloves have been replaced.

Butyl and Hypalon Gloves are also available.

See Figures 15 and 16 for details on attaching the glove to the glove box.

Figure # 15 Sleeve Attachment to Glove box

1. Place sleeve on chamber.

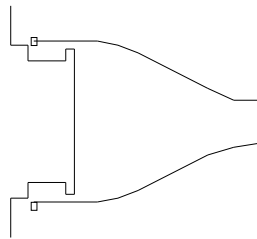

2. Place rubber band over sleeve.

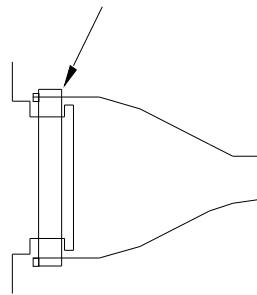

3. Place clamp over rubber band & tighten lightly.

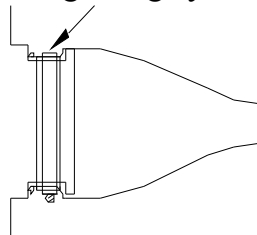
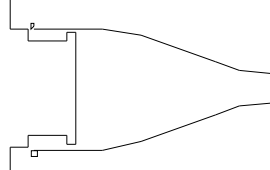
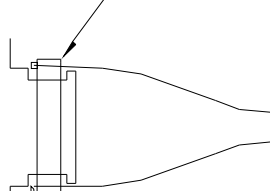

Figure # 16 Gloveless Sleeve and Gloveless Sleeve Cuff Attachment

1. Place sleeve on chamber.



2. Place rubber band over sleeve.



3. Place clamp over rubber band & tighten lightly.

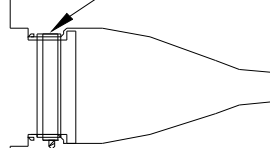

4. Place plastic cuff support over sleeve.

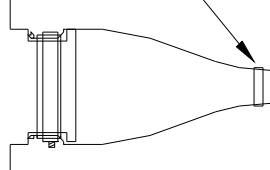

5. Roll sleeve over plastic cuff support.

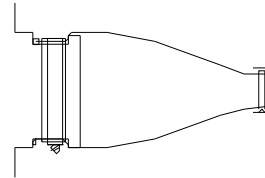

6. Stretch latex cuff over sleeve & cuff support.

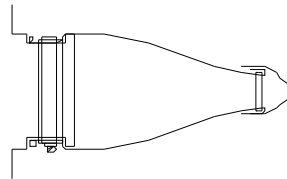

7. Place "O" ring on top of cuff & sleeve in groove of plastic support.

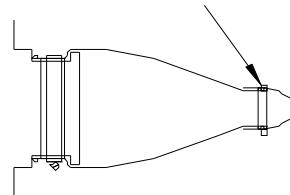

Replacement Parts and Accessories

6565000	Accessory Mount System for Vinyl Glove Boxes
8531045	Added Capacity Dryer for Dehumidification System
2600150	Additional Air Circulation Fan (100-160 cfm)
8150100	Airlock, Automatic Purge System
8400025	Airlock, Manual Purge
8400026	Airlock, Pass-Thru (<i>polymer style</i>)
8400075	Airlock, Sliding Shelf
8540025	Arm Port Plugs (each)
8540020	Arm Port Plugs (pair)
5800024	Atmosphere Filter (HEPA), Replacement
8537025	Atmosphere Filtration System (HEPA), Recirculating
5800026	Carbon Filter
8200025	Chiller
1601434	Cuff Latex (#9/Large), 12 Pair (Replacement for Gloveless Sleeves)
1601432	Cuff, Latex (#7/Small), 12 Pair (Replacement for Gloveless Sleeves)
1601433	Cuff, Latex (#8/Medium), 12 Pair (Replacement for Gloveless Sleeves)
1601436	Cuff, Latex (Mixed Set 4 med./4 small/ 4 Large), 12 Pair (Replacement for Gloveless Sleeves)
8531025	Dehumidification Apparatus (automatic) Use with Humidity Controller
8531026	Dehumidification System, Manual
8400033	Door, Large Side 18"/45 cm x 18"/45 cm
8546050	Dry Gas Purge System (Automatic to be used with Humidity Controller ONLY)
8531030	Drying Capsule with Desiccant and Fittings
8514025	External Accessory Shelf
1601230	Extra Copper Tubing 1/4" O.D. (price per foot)
2804970	Extra Manual Purge Valve Assembly(Poly Chamber)
1601806	Extra Tygon Tubing 1/4" I.D x 3/8" O.D. (price per foot)
1601805	Extra Tygon Tubing 1/4" I.D. x 7/16" O.D. (price per foot)
8544220	PID Heater 220v
8544110	PID Heater 110v
8513025	Feed Thru Adapter
2804700	Flow Meter, 0-60 SCFH, w/valve
2804785	Flow Meter, 0-180 SCFH, w/valve
7004020	Gas Regulator for Forced Air (O2 at 20.9%)
7004000	Gas Regulator Nitrogen CGA 580
7004015	Gas Regulator Nitrogen/Carbon Dioxide, CGA 320
7004035	Gas Regulator Oxygen (for 100% O2 Tanks)
8300025	Gloveless Sleeve with Cuff (Basic), pair
8300050	Gloveless Sleeve with Vacuum Purge System
8541110	Humidification Apparatus, Ultra Sonic
8534025	Humidity Controller Model
2200110	Hygrometer, Digital
8511025	Internal Shelf Assembly (<i>polymer glove boxes only</i>)
2201025	Ionizer, Workstation
1601881	Iris Port (each)
1601880	Iris Port (pair)